

ASSA ABLOY
Opening Solutions

eCLIQ

Your key to digital access

Experience a safer
and more open world

eCLIQ – the innovative new electronic locking system: An innovation with time-tested technology

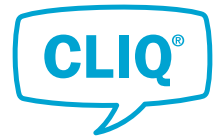

The new eCLIQ electronic locking system is based on time-tested CLIQ technology from ASSA ABLOY, used the world over. Building owners and users alike have been appreciating the benefits of mechatronic CLIQ systems for many years in both small and extensive, complex locking systems.

The core of the new, exclusively electronically coded eCLIQ locking system is its unique, innovative locking cylinder technology.

Thanks to its set-up and structure, the eCLIQ locking cylinder achieves an unprecedented level of compactness and flexibility.

Remarkably durable, the eCLIQ key is also a true innovation in an unusual, striking design. Fitted with a latest generation chip, the entire eCLIQ system is faster, more powerful, more secure and more energy-efficient than conventional locking systems.

A secure investment:
The eCLIQ electronic
locking system
boasts impressive
performance in
many areas of use.

Only eCLIQ can offer such advantages.

The eCLIQ electronic system is a completely new development on the international locking system market.

This applies not only to its technology, but also to its design and user convenience. Since many customer requirements from a wide range of industries were taken into account during the eCLIQ's development, the system is extremely user-oriented and offers numerous advantages down to the tiniest detail.

eCLIQ – perfect in every situation.

The eCLIQ system is generally suitable for designing locking systems of all sizes and in all types of buildings. Its specific features make it particularly beneficial for certain areas of use.

A few examples

- **Supply, infrastructure and industrial enterprises:**

In addition to its flexibility, eCLIQ's robust design and long service life are particularly advantageous and cost-efficient.

- **Museums, galleries, events centres:**

It blends into design-accented doors and environments without protrusions thanks to the locking cylinder's compact design and the available lengths from 30 mm on each side.

- **Heavily used doors and key switches, such as those at car park entrances:** eCLIQ is particularly suitable in such cases thanks to the cylinder's durable design, maintenance-free for up to 200,000 cycles.

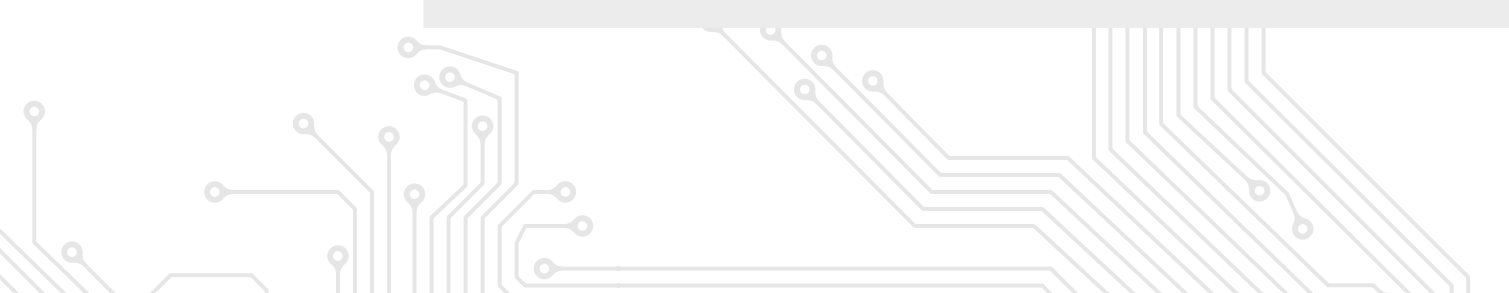

eCLIQ: The key to electronic locking

More secure, more efficient and longer-lasting than conventional locking systems

eCLIQ is an exclusively electronic locking system based on precision mechanical components and microelectronic modules containing ASSA ABLOY's CLIQ® technology. The microelectronics in the programmable, waterproof key and

the compact electronic locking cylinder ensure maximum security – reliably and with no complications. eCLIQ solves the problem of lost keys. Locking authorisations can be easily deleted since each key can be programmed individually.



Simple, swift installation of cylinders with no wiring

New, future-oriented CLIQ® chip generation with AES encryption and fast processing speed with efficient energy management



The electronic contact between keys and locking cylinders serves to transmit both power and data securely

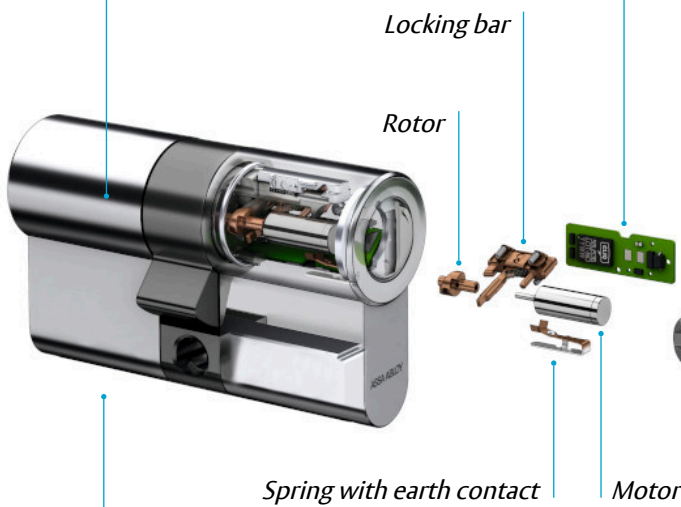

Keys and cylinders can be programmed with flexible locking authorisations and schedules



Waterproof and dust-proof key bow with battery and electronics board



Rapid replacement of the standard battery in the key – without using any tools

Management of the eCLIQ system

Maximum flexibility in issuing and blocking access authorisations

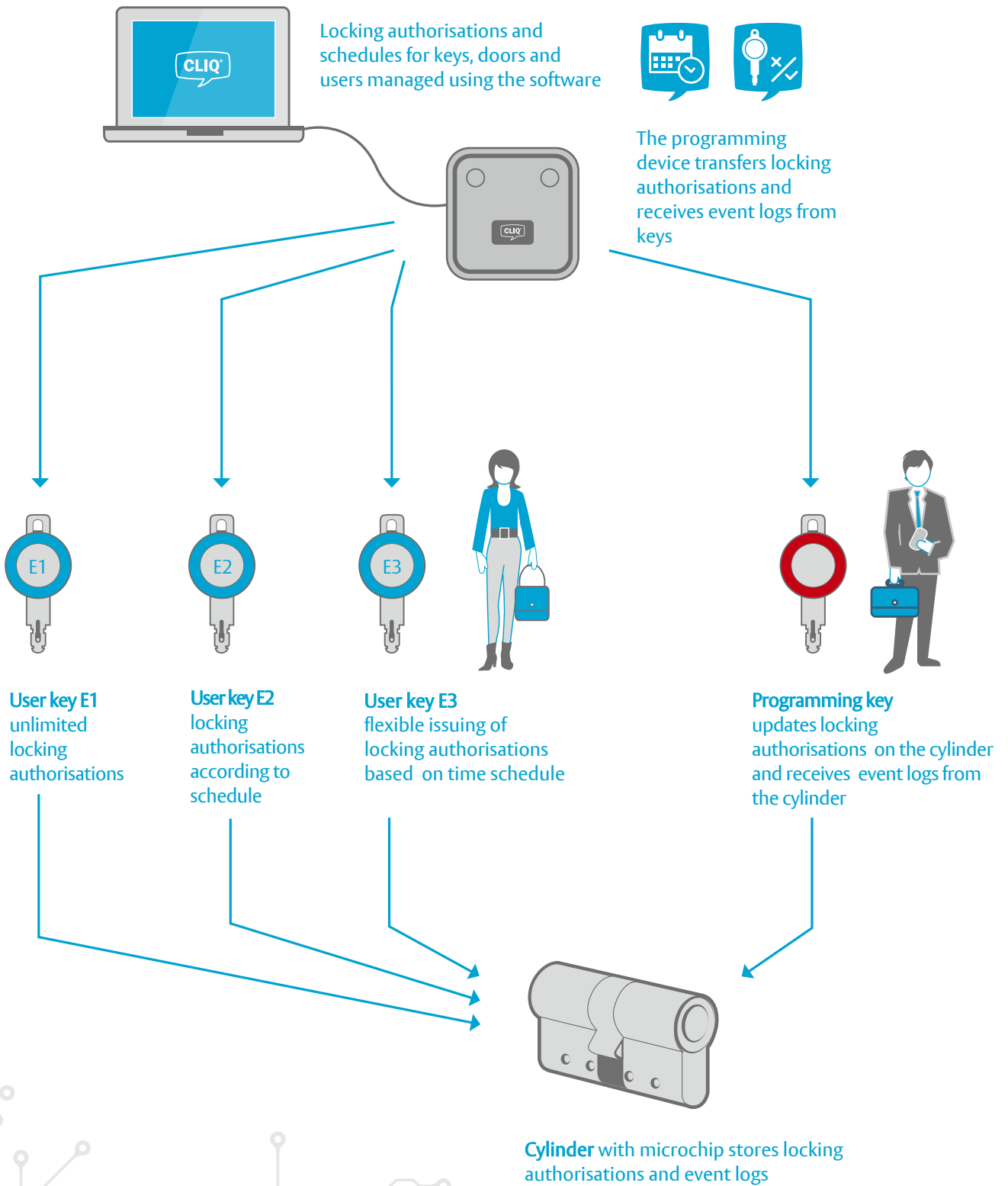

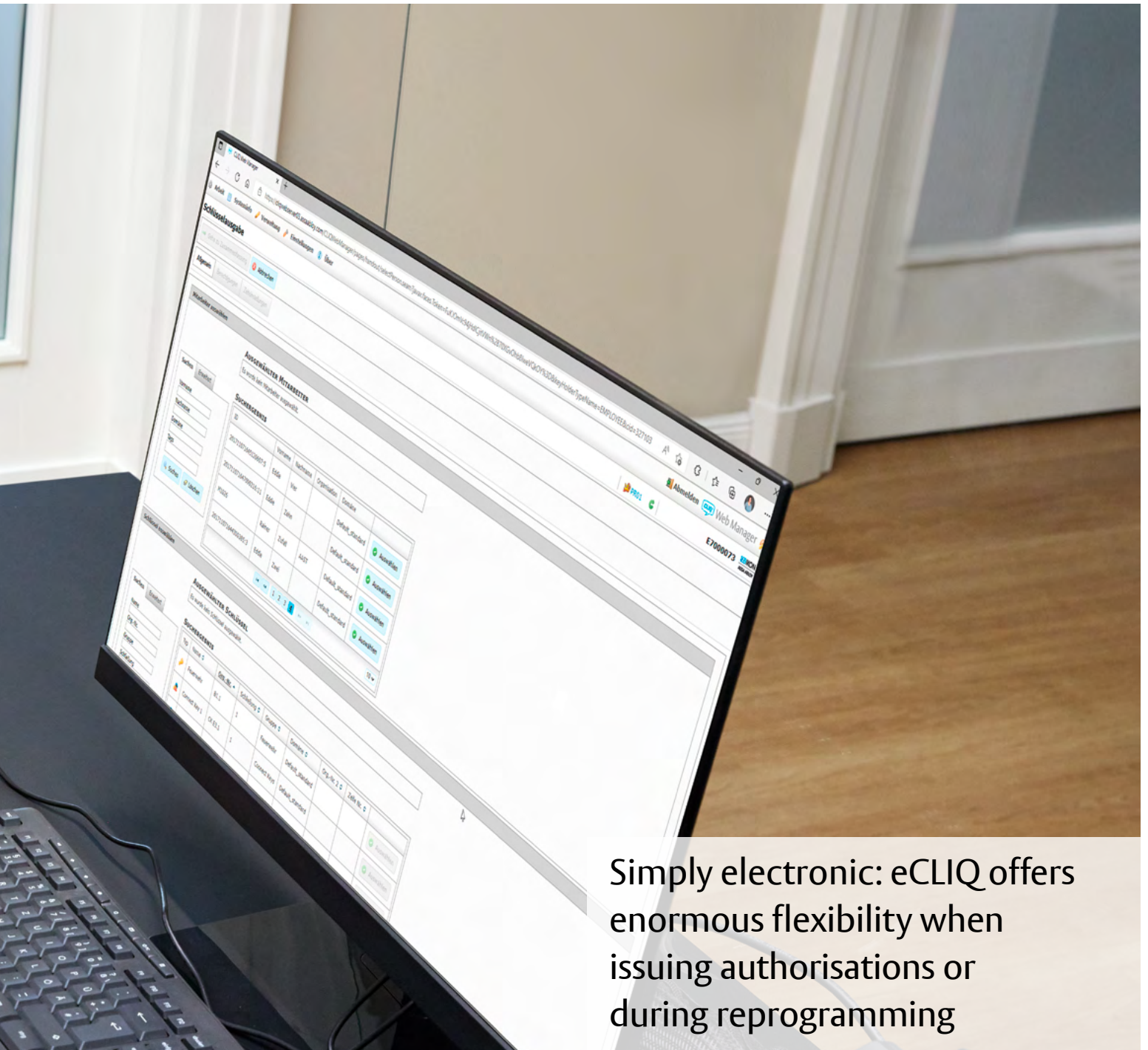

Simply electronic: eCLIQ offers enormous flexibility when issuing authorisations or during reprogramming

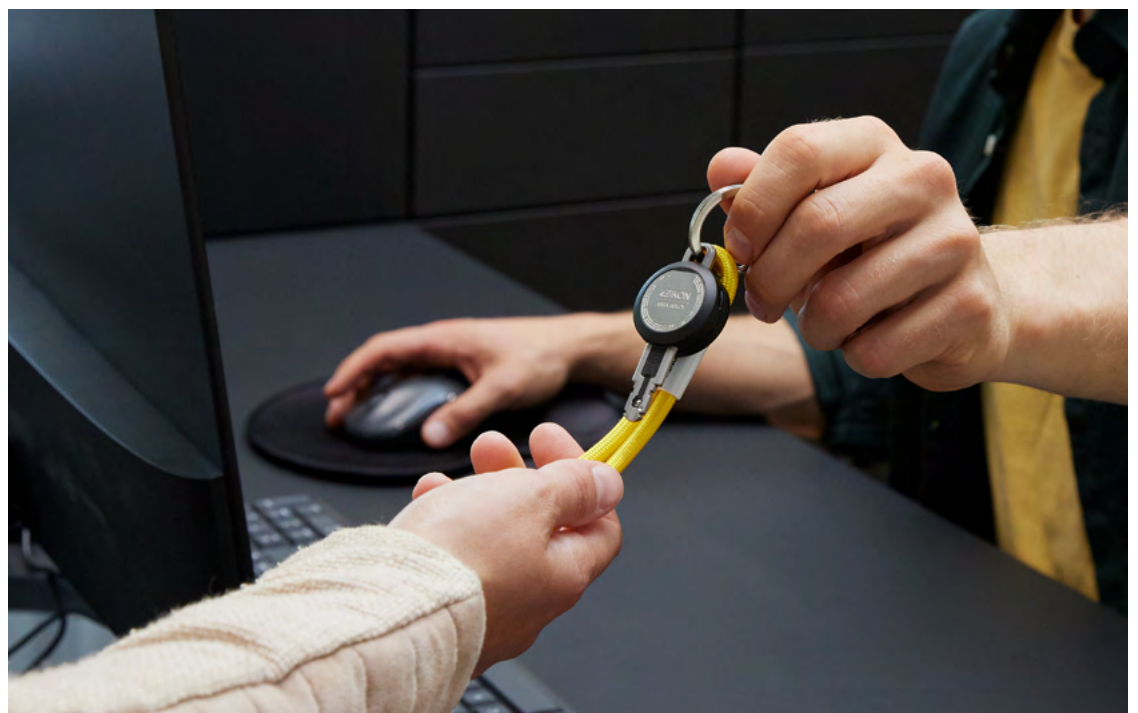

eCLIQ – perfect in every situation

Easy installation – no cables required

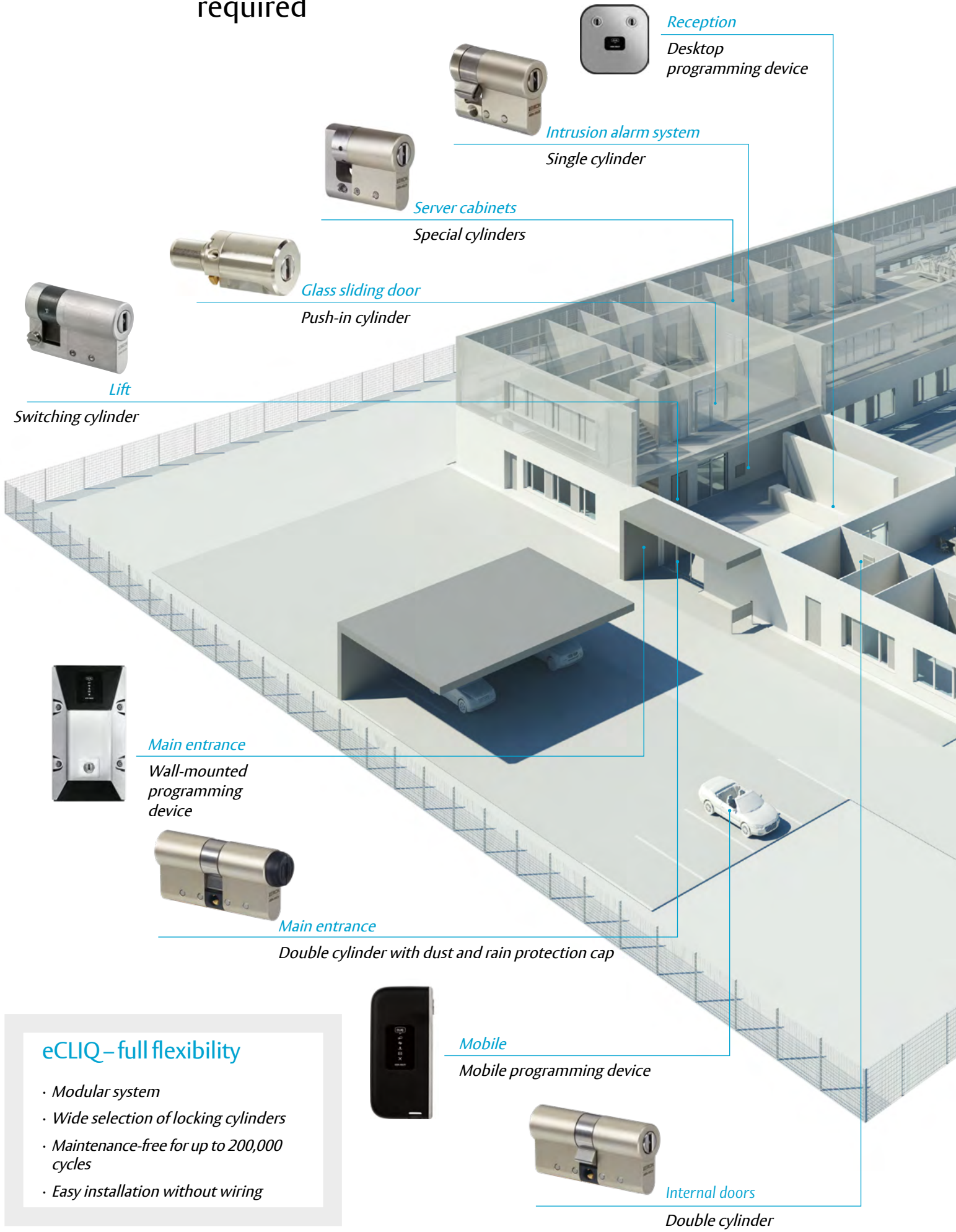

Reception
Desktop programming device



Intrusion alarm system
Single cylinder



Server cabinets
Special cylinders



Glass sliding door
Push-in cylinder



Lift
Switching cylinder



Main entrance
Wall-mounted programming device



Main entrance
Double cylinder with dust and rain protection cap



Mobile
Mobile programming device



Internal doors
Double cylinder

eCLIQ – full flexibility

- Modular system
- Wide selection of locking cylinders
- Maintenance-free for up to 200,000 cycles
- Easy installation without wiring



*Document cabinet
Furniture cylinder*



*Machine
Switching cylinder*



*Control cell
Round cylinder*



*Outdoor container
Padlock cylinder*



*Furniture
Furniture lock*



*Storeroom door
Thumbturn cylinder*



*Fire service safe
Key safe tube cylinder*



*Letterbox system
Locking lever cylinder*

The compact eCLIQ locking cylinder provides extremely high security. Thanks to the large selection of different cylinder types, the system is suitable for applications of all kinds – from company entrance doors through to securing lifts, doors, cabinets and intrusion alarm systems.

With comprehensive certification for a variety of applications, including outdoor installation, building operators are superbly equipped for all current and future requirements.

The eCLIQ locking system in action

Maximum flexibility and greater security for companies

Personnel changes, temporary employment relationships and partnerships with other companies are standard business practices. Lost keys can easily fall into the wrong hands.

The eCLIQ locking system overcomes the difficulties associated with constantly changing access authorisations. With its optimal combination of flexibility, security and user convenience, eCLIQ is the logical solution.

Examples

Management while out and about



The administrator manages the system on CLIQ® Web Manager at any time and from anywhere. The only requirement is internet access.

Management on site



The receptionist programs and controls the issuing and return of user keys (E3 remote) on CLIQ® Web Manager.

Employees on site

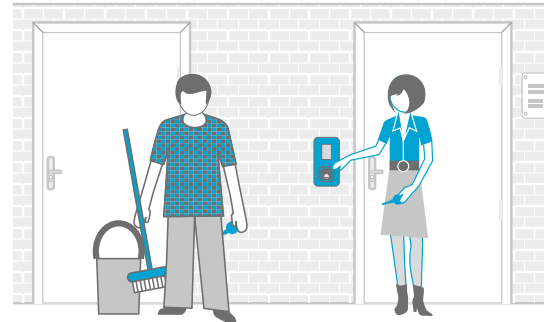

An "E3-remote" is issued to cleaning staff for doors with a low security category, for example, due to changing requirements and high staff turnover rates.

Employees regularly update the validity of their key (time and remote) via remote programming devices to minimise the risk of key loss.

eCLIQ is longer-lasting, more secure and more efficient than conventional locking systems and protects properties of all types and sizes with flexible issuing of access authorisations.

Employee out and about

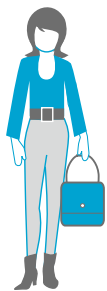

An employee is out on a job and needs new access authorisations immediately. The employee informs the administrator, who implements these changes using a mobile programming device.

Employee or contractor on site or out and about

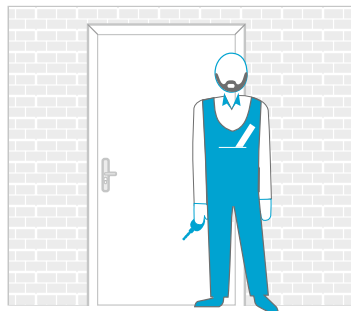

Security personnel use CLIQ® Web Manager and the programming key in a different location to change access authorisations to the locking cylinders.

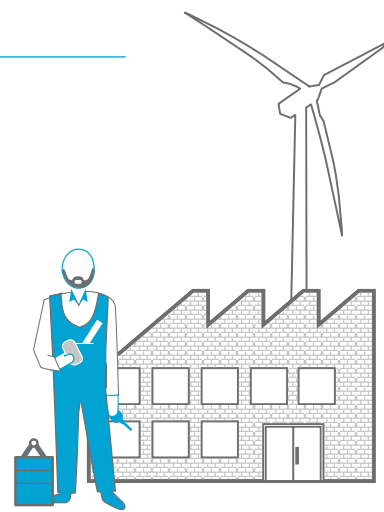

Users can receive temporary access authorisations with their keys (E3 remote) for other locations. These rights are issued using the mobile programming device and a mobile telephone.

A decorative graphic of grey circuit lines with circular nodes, extending from the bottom right towards the center of the page.

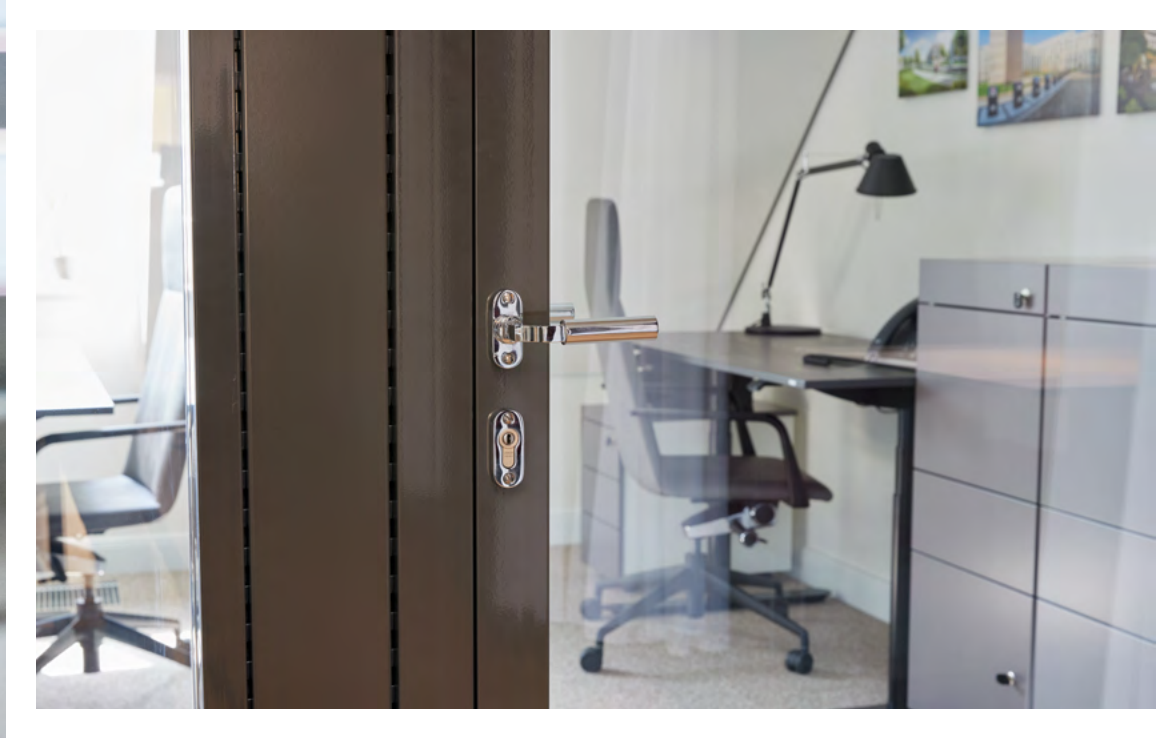

Eminently suitable for restricted-access areas: eCLIQ with the latest chip generation for optimum encryption and protection against tampering and electronic attacks



eCLIQ system components

Keys and cylinders

- Compact key design ensures stability and a long service life
- Reversible key: always fits no matter which way it is inserted into the cylinder
- Visual and acoustic signals for access authorisations, time zones and battery status
- Protected against temporary immersion in water (IP67)
- Available in three models (E1, E2 and E3)
- Integrated standard battery (CR2450 button cell) of up to 100,000 locking procedures (service life of up to 10 years)
- No tools needed to change battery

Programming key

The red programming key carries changes to rights and event logs between software and locking cylinders. Also used for authorisation for use of the software.



Dynamic User key E1, E2, E3

- E1** for simple access authorisations
- E2** with temporary access authorisations and event logs
- E3** flexible access authorisations and event logs

The Dynamic User key has LED indications **and** acoustic signaling of battery status and access rights.



CLIQ Connect key

CLIQ® Connect is a supplement to the eCLIQ solution and allows users to update keys anywhere at any time using an iOS or Android device. Users can use the CLIQ Connect app to securely update their access authorisations without an additional programming device. New rights are quickly and simply transmitted onto the eCLIQ key via Bluetooth®.

Basic User key

Available in the same E1, E2 and E3 access authorisation versions as the Dynamic User key.

The Basic User key has LED indications but **no** acoustic signaling of battery status and access rights.



"Beluga" user key

Designed for outdoor use (-30 °C to +50 °C) – for example, storage in fire service safes.



"Ex" user key

User keys are optionally available for use in Zone 1 explosion-prone areas (II 2G EX IB IIB T4 Gb)

- Highly secure protection against tampering and intelligent attempted break-ins
- Integrated microchip to store access authorisations and event lists
- Use under challenging environmental conditions (temperature range: -25 °C to +85 °C)
- Maintenance-free up to 200,000 cycles (with integrated lubricant reserve)
- The central keyway and low core protrusion ensure problem-free installation in conjunction with security fittings and other locks
- Optional with extended drilling protection
- Comfort function for emergency key

Cylinders

The cylinder automatically checks all programmed access authorisations and rejects unauthorised keys.



Authorisation

1,000 memory cells for individual keys and groups (each containing over 65,000 keys)

Blocking functions for up to 1,500 keys

Event memory for up to 750 events

Optional dust and rain protection cap External cylinders for all weather conditions, e.g. on radio masts. The cap ensures IP55 protection and is suitable for profile cylinders.



eCLIQ also available with transponder Key with integrated RFID chip for integrating into transponder-based systems, e.g. EAC systems.

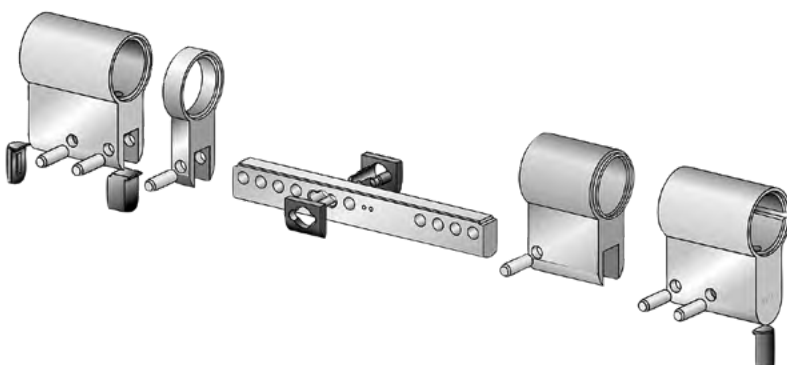

Flexible modular system

Euro profile cylinder in lengths starting from 28 mm per side. Standard lengths extendible in 5 mm increments with total length between 60 and 120 mm. Special lengths with a total length of 240 mm are also available.

eCLIQ non-standard cylinders

Finishes and options



WP- Weatherproof cover



IP 55 - Dust and Rain cover

AT - ATEX



ATEX Approval for Zone 1
II 2G Ex ib IIB T4 Gb

MECH - Mechanical/Dummy core



Rotary secured core with no electronics
Can be opened by any eCLIQ key
from any system

KNF=X - Non-standard Thumbturns*



KNF=1..



KNF=2..
(STANDARD)



KNF=7..



KNF=9..



KNF=91..



KNF=92..



KNF=94..

Available finishes



Satin Nickel (standard) - SN



Satin Chrome - SC



Polished Brass - PB



Satin Brass - SB



Gloss Brown - GB

AD - Anti-Drill Core

*Not all available finishes are possible for all Non-standard Thumbturn cylinders.

eCLIQ system components

Management software

For programming access authorisations and schedules for keys, doors and users, CLIQ® systems offer two versions of a reliable and uncomplicated management software:



The locally installed management software

CLIQ® Local Manager

- Locally installed management software for individual and several CLIQ® locking systems
- Intuitive and user-friendly for easy managing of CLIQ® locking systems in small and medium-sized companies
- Plug-and-play activation
- Improved security thanks to two-factor authentication
- Supports GDPR-compliant use
- Flexible and time-saving pre-modifications without the key owner needing to be present
- Tiered service levels
- User notifications to increase efficiency
- Integrated workflows take into account practice-relevant work steps
- Reports easily created
- Easy administration of different user groups
- Easily accessed .log files help to provide rapid support processes
- High acceptance among employee and works councils thanks to technical approver function

The new optional extension of the CLIQ®-Local-Manager software “Remote” enables new time-saving functions without the system being connected to the internet:

- The assignment of schedule changes increases the flexibility of employees and service providers
- Use of up to 3 wall programming devices for convenient updates and acceptance among key users
- The revalidation function minimises the risk if a key is lost
- Enables user keys and the associated access authorisations to be updated independently of the administrator
- GDPR-compliant use of event logs for specific incidents to minimise damage and ensure traceability



The Internet-based management software

CLIQ® Web Manager

- Allows locking system management to be connected online, thus providing access at any time wherever there is an internet connection
- Perfect for managing extremely large locking systems and systems spread across several sites
- Web application for multiple administrators, can be accessed by the client via a standard internet browser
- High-performance design enables management of locking systems of any size
- Technical approver function for obtaining events logs ensures high personal data protection

- Step-by-step user guidance and clear user interfaces reduce the amount of training required
- Revalidation options help to block lost keys and safeguard the system security
- Central server and data storage plus network-compatible client/server design
- Network connection, 128 bit SSL encryption and additional security with software certificates for client and server



CLIQ[®] Local Manager

Locally installed management software for individual and several CLIQ[®] master key systems











Key features of the CLIQ® Local Manager software



Perfect integration of the software with conventional Windows computers.

Key features of the CLIQ® Local Manager software



	<p>Intuitive, user-friendly software management</p>		<p>Two-factor authentication using customised programming key and PIN codes</p>
	<p>Integrated management of additional mechanical components</p>		<p>Up to 32 time zones per user key</p>
	<p>Continuous product care and maintenance</p>		<p>Demo version with extensive functions</p>
	<p>Client-specific, tiered service levels</p>		<p>Simple migration of older manager solutions with high level of recognition for key functions</p>
	<p>Based on current, consistently further developed Microsoft architecture</p>		



CLIQ® Web Manager

Secure and intuitive software for ongoing security management in your company



Key features of the CLIQ® Web Manager software



The CLIQ® Web Manager supports efficient workflow management with electronic master key systems and enables you to grant access at specific points selectively according to your security requirements. You can create individual schedules effortlessly.

The CLIQ® Web Manager supports you optimally in line with your operational processes during secure access control, whether in a self-managed IT environment or with CLIQ® software as a service.

Key features of the CLIQ® Web Manager software



Perfect for managing extremely large master key systems and systems distributed across multiple sites.

	Secure log-in using HTTPS and two-factor authentication		Keys can also be revalidated offline
	Convenient management of rights using profiles		Certified barrier-free design
	Up to 32 time zones per user key		Secure thanks to regular PEN tests
	Integration with other systems using web services		Diverse hosting and SLA options
	Multiple-user and several-workstation solution		

eCLIQ system components

Programming devices



The programming device is used to read event logs and change time settings and access authorisations, depending on the key type.



Desktop programming device For local and central use

Desktop programming device

- Communications interface for secure data transmission between eCLIQ® management software and programming key
- Programming of user keys and the reading station for the log memory in the time and remote user key
- USB connection



Wall-mounted programming device Local and de-centralised use (e.g. at entrances)

Wall-mounted programming device

- Remote programming of access authorisations and validities of user keys (time and remote)
- Transmission of programming orders to programming keys
- For decentralised management
- Programming functions run automatically with visual and acoustic signals
- Power supply via 12 – 24 V mains connection or power over Ethernet
- Outdoor version for areas requiring protection from vandalism (protection rating IP65 and IK09 – vandal-proof)
- Data transmission via standard Ethernet cable
- Protected against dripping water



Mobile programming device Mobile use directly by the key holder

Mobile programming device

- Remote programming of access authorisations and validities of user keys (time and remote)
- Transmission of programming orders to programming keys
- For decentralised management
- Acoustic and optical signals for operating status and activity progress
- Data transmission to the mobile device via Bluetooth on a smartphone or tablet and via USB to PC
- Power supply via standard batteries
- Micro USB connection for data exchange via cable
- Protected against dripping water



The ASSA ABLOY Group is the global leader in access solutions. Every day, we help billions of people experience a more open world.

ASSA ABLOY Opening Solutions leads the development within door openings and products for access solutions in homes, businesses and institutions. Our offering includes doors, door and window hardware, locks, access control and service.

ASSA ABLOY
Opening Solutions

ASSA ABLOY Partner:

RightAccess Ltd
Beresford House
2 Beresford Road
Coleraine
BT52 1GE

+44 333 303 4321
support@rightaccess.co.uk
rightaccess.co.uk

ABLOY UK
Portobello Works
School Street
Willenhall
West Midlands
WV13 3PW

+44 1902 364 500
info@abloy.co.uk
abloy.co.uk